

532-60 AGRI TELEHANDLER

3.0T DIESEL 6.0M TELEHANDLER



SPECIFICATION SERIES III – AGRIC LOADALL 532-60/532-70/536-95/542-70/560-80

STATIC DIMENSIONS

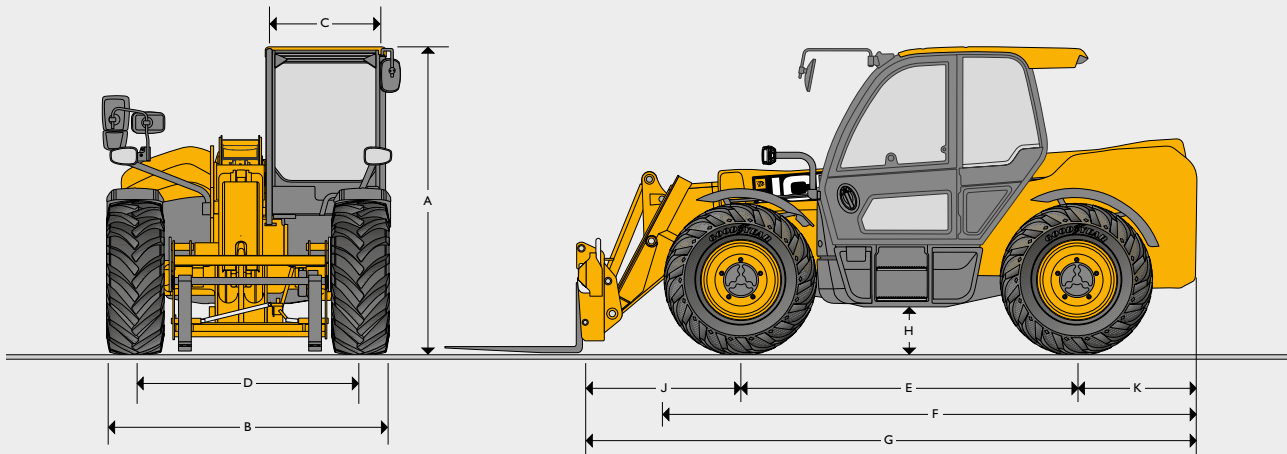

STATIC DIMENSIONS

Machine model		532-60	532-70	536-95	542-70	560-80
A Overall height	m	2.49	2.49	2.49	2.49	2.67
B Overall width (over tyres)*	m	2.28	2.34	2.34	2.34	2.49
C Inside width of cab	m	0.97	0.97	0.97	0.97	0.97
D Front track	m	1.81	1.81	1.87	1.81	1.99
E Wheelbase	m	2750	2750	2750	2750	2750
F Overall length to front tyres	m	2.75	4.38	4.38	4.38	4.55
G Overall length to front carriage	m	4.69	4.99	4.99	4.99	5.28
H Ground clearance	m	0.37	0.4	0.4	0.4	0.43
J Front wheel centre to carriage	m	1.15	1.23	1.21	1.23	1.23
K Rear wheel centre to rear face	m	0.65	1.01	1.03	1.01	1.01
Turn radius - over tyres	m	3780	3780	3780	3780	4100
Carriage rollback angle -for shovel in carry position	degrees	42.6	42.6	41	42.6	43
Carriage dump angle - for shovel at full height	degrees	42.5	37.5	24	37.5	43.5
Weight (AGRI, AGRI, AGRI Super)	kg	7520	7600	8760	8300	10775
Weight (AGRI Pro)	kg	NA	8370	8820	8520	11790
Tyres		400/80 R24	460/70 R24	460/70 R24	460/70 R24	480/80 R26

Machine shown with roof mounted air conditioning fitted.

*Dependant upon tyre specified.

HIRE

SALES

SERVICE

LEASE

TRANSPORT

532-60 AGRI TELEHANDLER

3.0T DIESEL 6.0M TELEHANDLER



SERIES III – AGRI LOADALL 532-60/532-70/536-95/542-70/560-80

SPECIFICATION

OPTIONS	532-60 AGRI	532-70 AGRI	532-70 AGRITORQUELOCK4	532-70 AGRISUPER	536-95 AGRITORQUELOCK4	536-95 AGRISUPER	542-70 AGRITORQUELOCK4	542-70 AGRISUPER	542-70 AGRIPRO	560-80 AGRISUPER	560-80 AGRIPRO
Drivetrain											
109hp/81kW	X	X	X	-	X	-	X	-	-	-	-
125hp/93kW	-	-	-	X	-	X	-	O	-	-	-
145hp/108kW	-	-	-	O	-	O	-	X	X	X	X
Auto Reversing Fan	X	X	X	X	X	X	X	X	X	X	X
40kph Powershift (4-speed)	X	-	-	-	-	-	-	-	-	-	-
40kph Powershift (4-speed TorqueLock in 4th gear)	-	X	X	-	X	-	X	-	-	-	-
40kph Autoshift (6-speed TorqueLock in 5th & 6th gear)	-	-	-	X	-	X	-	X	-	X	-
40kph DualTech Variable Transmission, (combined Hydrostatic and Mechanical Drive with Flexi Mode)	-	-	-	-	-	-	-	-	X	-	X
Electrical 2/4WD disconnect	X	X	X	X	X	X	X	X	-	X	-
Auto 2/4WD disconnect	-	-	-	-	-	-	-	-	X	-	X
Limited slip differential in front axle	O	O	O	O	O	O	O	O	X	O	X
Smart Hydraulics											
Auto - Smooth Ride System	O	O	X	X	X	X	X	X	X	X	X
Electro hydraulic pin-locking	O	O	X	X	X	X	X	X	X	X	X
High flow double acting - auxiliary	O	O	O	O	O	O	O	O	X	O	X
Double acting - single rear auxiliary	O	O	O	O	O	O	O	O	O	O	O
Double acting - twin front auxiliary	O	O	O	O	O	O	O	O	O	O	O
Double acting - twin rear auxiliary	O	O	O	O	O	O	O	O	O	O	O
Sway: Electro-Hydraulically controlled chassis levelling	-	O	O	O	O	O	O	O	-	-	-
Cab											
Air suspension seat, with seat-mounted control pod	X	X	X	X	X	X	X	X	-	X	-
Heated air suspension seat with seat-mounted control pod	O	O	O	O	O	O	O	O	-	O	-
Half leather, heated and vented air suspension seat with seat-mounted control pod	-	-	-	O	-	O	-	O	X	O	X
Left hand armrest	X	X	X	X	X	X	X	X	X	X	X
Auto temperature climate control, air conditioning	O	O	O	O	O	O	O	O	O	O	O
Heated screen – rear	O	O	O	O	O	O	O	O	O	O	O
Heated screen – front	O	O	O	O	O	O	O	O	O	O	O
External screen guard – front	X	X	X	X	X	X	X	X	X	X	X
Lighting											
Halogen worklights – 2x front cab, 2 rear cab, 2x boom, 1x hitch light & interior light	X	X	X	-	X	-	X	-	-	-	-
LED worklights – 2x front cab, 2 rear cab, 2x boom, 1x hitch light & interior light	O	O	O	X	O	X	O	X	-	X	-
360° LED worklight package – 2x front cab & 2x rear chassis	O	O	O	O	O	O	O	O	X	O	X
LED road light package – front and rear road lights number plate light	O	O	O	O	O	O	O	O	O	O	O
Braking											
Twin line hydraulic trailer brakes* with 7 pin electrics & E.B.S socket	O	O	O	O	O	O	O	O	O	O	O
Twin line air trailer brakes* with 7 pin electrics & A.B.S socket	O	O	O	O	O	O	O	O	O	O	O
Twin line air trailer brakes* & single line hydraulic with 7 pin electrics & A.B.S socket	O	O	O	O	O	O	O	O	O	O	O
Other											
32T Hydraulic pick up tow hitch (must also take twin line trailer brakes)	O	O	O	O	O	O	O	O	O	O	O
Ladder mounted tow hitch (must also take twin line trailer brakes)	O	O	O	O	O	O	O	O	O	O	O
Boom ingress protection kit (7m & 8m only)	-	O	O	O	-	-	-	O	X	O	X
Remote centralised rear grease points (7m & 8m only)	-	O	O	O	-	-	O	O	X	O	X
Transmission belly guard kit	O	O	O	O	O	O	O	O	X	O	X

Standard X Optional O Not applicable -

*Complies as a European type approved vehicle as a T1 tractor. (Some options are territory dependant).

WA

NT

QLD

NSW

VIC

SA

532-60 AGRI TELEHANDLER

3.0T DIESEL 6.0M TELEHANDLER



SPECIFICATION SERIES III – AGRI LOADALL 532-60/532-70/536-95/542-70/560-80

AGRI AGRI TORQUE LOCK 4 AGRI SUPER AGRI PRO

LIFT PERFORMANCE

Machine model	532-60	532-70	536-95	542-70	560-80
Lift capacity - maximum	kg 3000	3000	3000	4000	5500
Lift capacity to full height	kg 3000	2750	1600	2400	2750
Lift capacity at full reach	kg 1300	1350	500	1550	1700
Lift height	m 6.22	7	9.49	7.01	7.9
Forward reach at maximum lift height	m 0.87	0.48	2.43	0.48	0.92
Maximum forward reach	m 3.42	3.82	6.60	3.82	4.51
Reach with 1 tonne load	m 3.42	3.82	5.00	3.82	4.51
Placing height	m 5.42	6.3	8.78	6.3	6.64

Complies with stability test: ISO 22915-1:4:2010.

ENGINE

Manufacturer	JCB			
Model	EcoMAX			
Emissions level	UN Stage 3			
Aspiration	Turbocharged cooled			
Power rating				
Power @ 2200rpm	hp (kW)	109 (81)	125 (93)	145 (108)
Torque rating				
Torque @ 1500rpm	Nm	516	550	560
Specification				
Displacement	ltr	4.4	4.4	4.8
No. of cylinders		4	4	4
Bore size	mm	103	103	106
Stroke	mm	132	132	135

HYDRAULICS

Model	532-60	532-70	536-95	542-70	560-80
Operating system pressure	bar 241	241	241	260	260
Main hydraulics	l/min 140	140	140	140	140
Pump type	Variable Displacement				
Hydraulic cycle times					
Lift	seconds 4.0	4.5	5.6	5	7.4
Lower	seconds 3.8	5.7	6.3	5.2	8.3
Extend	seconds 5.8	6.7	9.4	6.7	8.3
Retract	seconds 4.4	5	10	5	5.9
Bucket dump	seconds 2.3	2.9	1.9	5	2.8
Bucket crowd	seconds 1.8	2.3	2.5	2.3	3.0